

PC 800

A PICTURE IS WORTH 1000 BENDS

Bend 1 of 8 Bends Assembly: C:\Bend\Parts\TP20546506.bend

Save Bend File Punch Die Manual Maintenance Parameter Notes Material Keyboard

Material
Thick 0.0550 Aluminum Width 3.000 Radius 0.0194 BA -0.0500

Machine Data

Y	11.414	Y
X	3.945	X
R	7.625	R

Tool Selection

Select	FABPNCH1	FABDIE_1
Position	0.000	0.000
Length		

Bend Data

Angle	90	0.0
Leg	4.015	Correct

Machine Data

TONS	0.7
OPENING	1.000
SPEED CHANGE	
Repeats	
Delay	
Retract	
Qty	124 of

Curve

Bend Number

Del ←

1 of 8

Copy →

Single START

Auto RUN



P.O. Box 519
82 Calvary Street, Waltham, MA 02453
Tel: (781) 893-3403
Fax: (781) 899-5708
E-mail: Sales@automec.com

AUTOMEK PC800

A PICTURE IS WORTH A THOUSAND BENDS

Automec's PC800 is a graphical control for its family of CNC backgauges that uses digital photos and 2-D graphics to make your pressbrake forming easier.

PC800 allows you to simply photograph your pressbrake tooling and bend sequences, and integrate them to your bending program. The PC based system uses a Microsoft Windows Pro/Win7-32Bit operating system which is familiar to most people and is seamless to network. Jobs can be programmed at the pressbrake or offline. Multiple pressbrakes can share information with a simple windows network that you can set up yourself. Files and folders with virtually infinite job and tooling storage are stored and sorted like any Windows equipped computer.



External USB Ports

Two external USB ports are provided so that data can be backed up and transferred between machines and digital photos can be quickly downloaded from your camera.

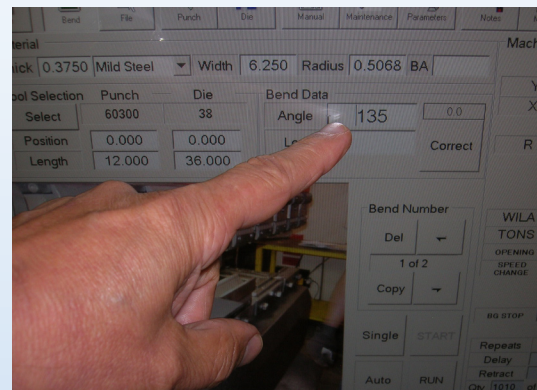

Data Entry Options

The PC800 offers two data entry methods. Data can be entered directly on the 15.1" color LCD industrial touch screen or using a standard PC keyboard and mouse. Switching between the two methods is seamless.

Virtually Infinite Job Storage

PC800 is powered by 1.8 GHz Dual Core CPU, 60GB Solid Slate hard drive and 2 GB DDR3 memory giving you virtually unlimited job tooling and materials library storage. Sub-folders can be created for cataloging bend jobs identical to the file management system used on any Microsoft Windows based computer.

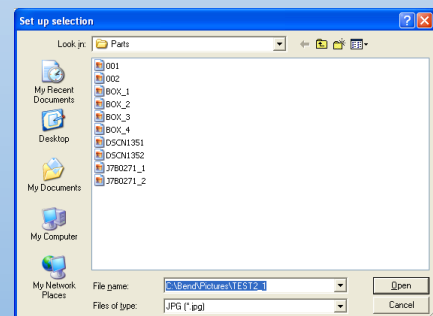

Advantage of PC800 over Traditional Graphical Controls

Multiple Programming Methods

In the Bend Wizard mode you simply select your tooling and material then enter the desired angles and bend legs. The 2-D graphical display shows the bend and tooling with a “before and after” illustration for every bend. Tooling interference can be detected and corrected before the first part is formed.

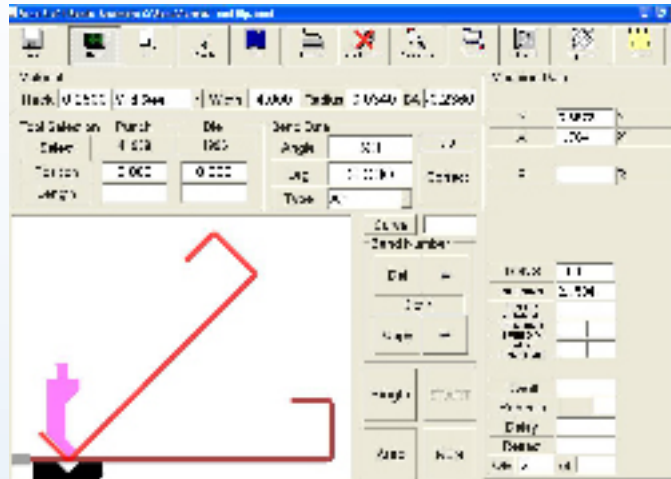

2-D Graphics Display

In addition to the 2-D graphical representation of the part forming sequence, PC800 allows you to use jpeg photos of your tools and workpiece to give the operator a better visual representation of each bend. It is as simple as downloading photos from your camera to your home computer. Photos enhance the 2-D graphic simulation because you can see the actual part with all of its cut-outs, holes, and insertion hardware. You can see how the operator positions the part on the die and the orientation of the gauge fingers.

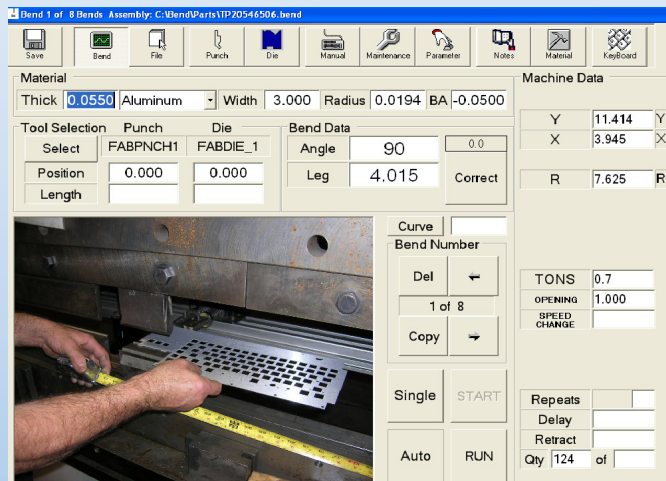

Jpeg Photo Display

Some operators will opt to use both methods of programming on the same job. The part can be created using the 2-D graphics mode to check for tooling interferences and then in the run mode the photos of each bend can be substituted for the 2-D graphics. You can use both methods of programming together or separately. The choice is yours.

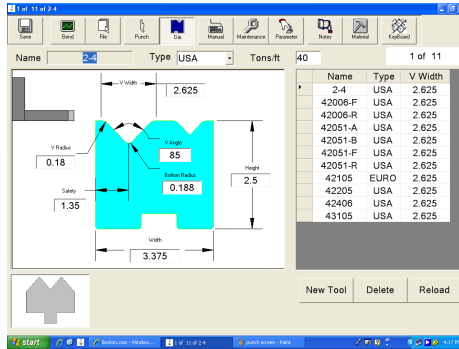
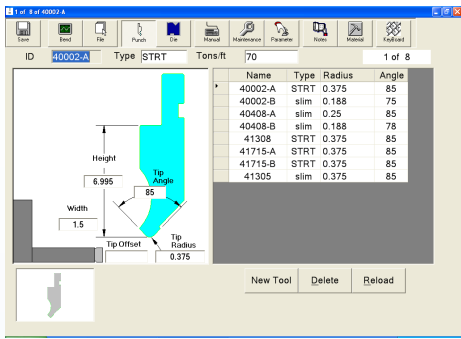

Easy Tool Programming

Tools are easy to program by just filling in the blanks on a template screen. Then select a tool profile from our pre-loaded images or photograph your own tool to store in the library.

Easy Tool Selection

Top and bottom tools are selected from a comprehensive tool library as well as various tool holders.

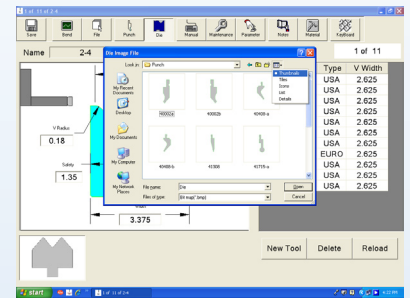
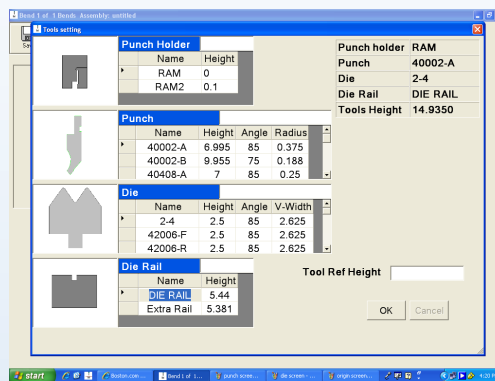

Multiple Die Setups

PC800 lets you load a separate tool set for each bend if required. The photo feature makes it easy to reproduce these elaborate progressive die setups the next time you run by visually displaying the job when recalled.

Material List

A material list can be created which carries all parameters including thickness, type of material, and springback characteristics.

When corrections are made to angles, you have the option of storing these corrections for that particular material type. This minimizes angle corrections the next time this material is used on another job.

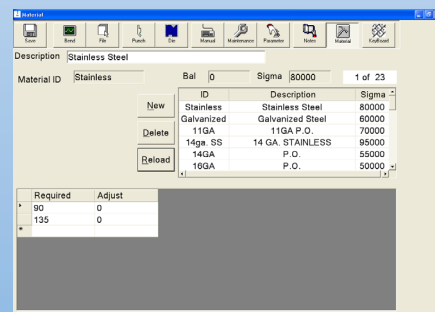

Technical Specifications

- Input power: 110 VAC, 1 Phase 50/60 HZ, 3 amps max
- Operating temperature: 0°C - 60°C
- 64 Optically isolated 24VDC inputs/outputs
- Automatic axis initialization procedure
- Programmable PLC functions and configurable machine parameters
- Integrated motion control card
- 32-bit floating point digital signal processing @ 60 MHz
- Real-time, multi-tasking firmware
- Industrial PC with MS Windows pro/Win7-32Bit Operating System *
- 1.8GHz Dual Core CPU, 60GB Solid State hard drive and 2 GB DDR3 memory
- 15.1" Color LCD Industrial touch screen
- Display with Standard PC keyboard
- 1 Serial, 1 Parallel port
- Deterministic logic & motion card control with safety interlocking and alarms
- Programming at the machine and off-line
- 2 external USB ports
- 4 internal USB ports
- X-axis travel 24" or 48"
- Y-axis travel 12" or 24"
- R-axis travel 8.5"
- Axis resolution .001
- Axis repeatability +/- .002
- Bend Wizard Graphical User Interface Software with off-line programming
- Remote access software for off-site trouble shooting
- Diagnostic & Servo tuning software
- Programmable delay and retract at pinch point
- Inch/mm conversion
- Available up to 3 axis
- 1 Year warranty



Designed/manufactured/supported in the USA

AVAILABLE UP TO 3 AXES

- X axis: Backgauge only
- Y axis: Ram control
- R axis: Vertical height adjustment of gauge bar

We recommend 3 axes to take advantage of the system capabilities. For example, with the R axis when the gauge fingers must pass closely over the top of the die, PC800 will know from your tooling info that it should raise the fingers above the die as it moves in and then drop the fingers down on top of the die.

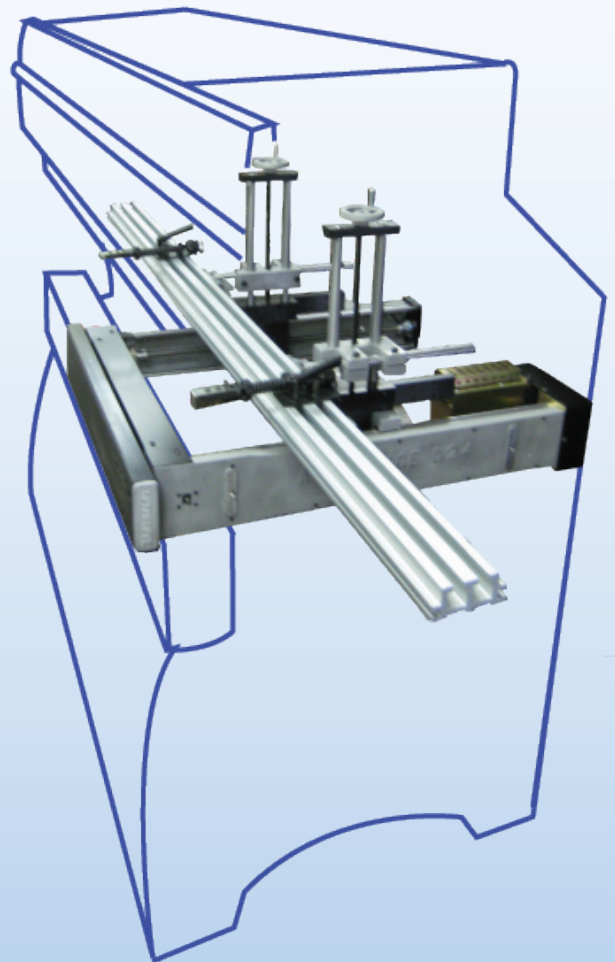

Upgrades: PC800 was designed to work with all Automec backgauges, even older models. You can utilize most mechanical backgauges made by us as early as 1976.



P.O. Box 519
82 Calvary Street, Waltham, MA 02453
Tel: (781) 893-3403
Fax: (781) 899-5708
E-mail: Sales@automec.com